

PNP Transistor

Features

- Low Saturation Voltage
- High Speed Switching Time
- As Complementary Type of the NPN

SOT-89

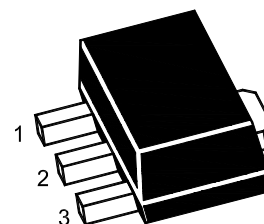

1.Base 2.Collector 3. Emitter

Equivalent Circuit

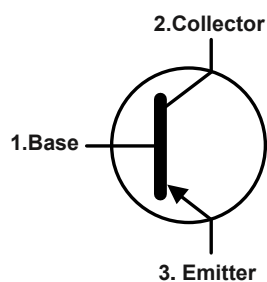

Absolute Maximum Ratings

Ratings at 25°C ambient temperature unless otherwise specified.

Parameter	Symbol	Value	Unit
Collector Base Voltage	$-V_{CBO}$	50	V
Collector Emitter Voltage	$-V_{CEO}$	50	V
Emitter Base Voltage	$-V_{EBO}$	5	V
Collector Current	$-I_C$	2	A
Maximum Power Dissipation	P_D	0.5	W
Junction Temperature	T_J	150	°C
Storage Temperature Range	T_{STG}	-55 to +150	°C

Thermal Characteristics

Parameter	Symbol	Value	Unit
Thermal Resistance Junction to Ambient	$R_{\theta JA}$	250	°C/W

Electrical Characteristics (T_A=25°C)

Parameter	Symbol	Min.	Typ.	Max.	Unit
DC Current Gain at V _{CE} = -2 V, I _C = -500 mA Current Gain Group O Y	H _{FE}	70 120 20	-- -- --	140 240 --	--
Collector Base Cutoff Current at V _{CB} = -50 V	-I _{CBO}	--	--	100	nA
Emitter Base Cutoff Current at V _{EB} = -5 V	-I _{EBO}	--	--	100	nA
Collector Base Breakdown Voltage at I _C = -100 μA	-V _{(BR)CBO}	50	--	--	V
Collector Emitter Breakdown Voltage at I _C = -1 mA	-V _{(BR)CEO}	50	--	--	V
Emitter Base Breakdown Voltage at I _E = -100 μA	-V _{(BR)EBO}	5	--	--	V
Collector Emitter Saturation Voltage at I _C = -1 A, I _B = -50 mA	-V _{CE(sat)}	--	--	0.5	V
Base Emitter Saturation Voltage at I _C = -1 A, I _B = -50 mA	-V _{BE(sat)}	--	--	1.2	V
Transition Frequency at V _{CE} = -2 V, I _C = -500 mA	F _T	100	--	--	MHz
Output Capacitance at V _{CB} = -10 V, I _E = 0, f = 1MHz	C _{ob}	--	40	--	pF

Typical Characteristic Curves

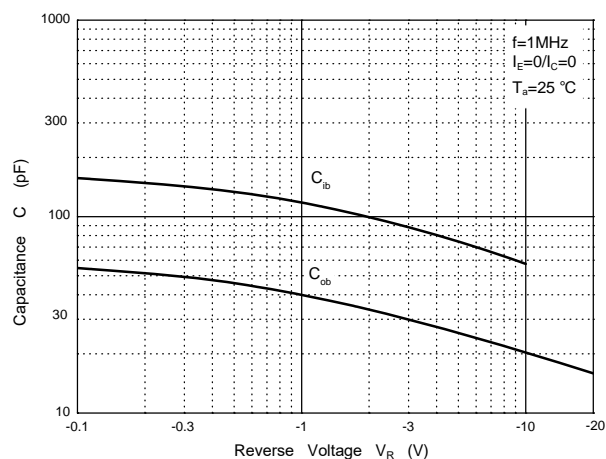
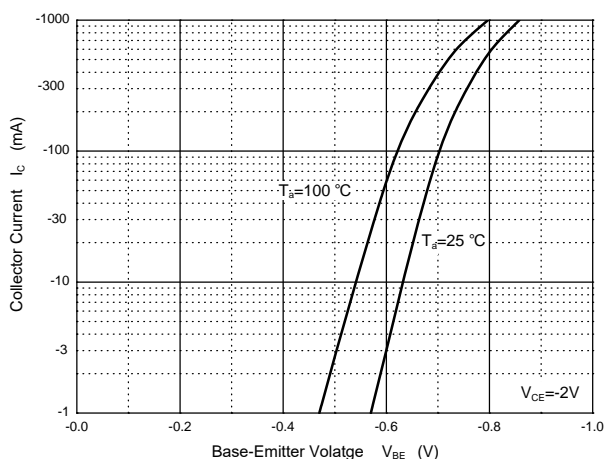
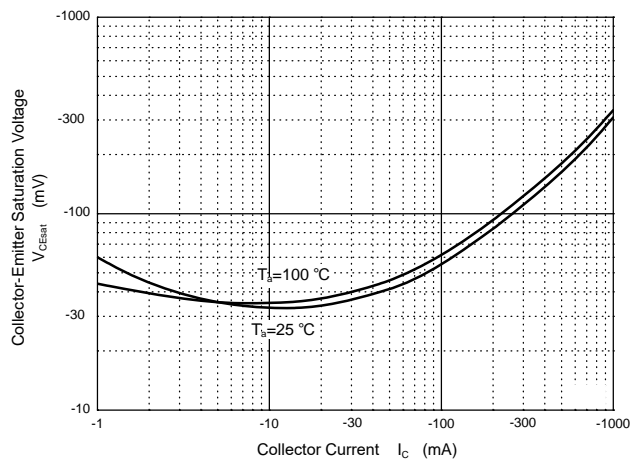
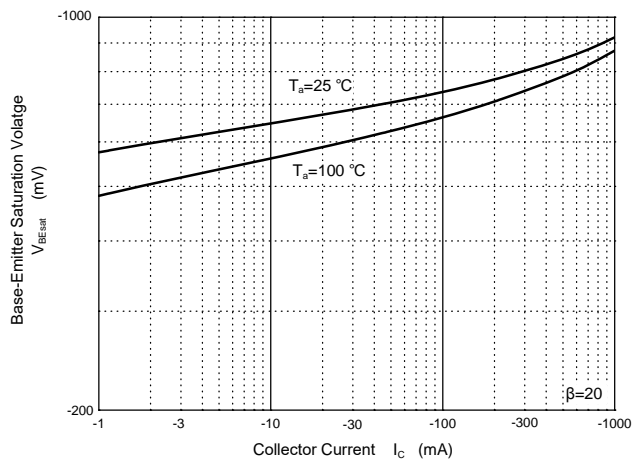
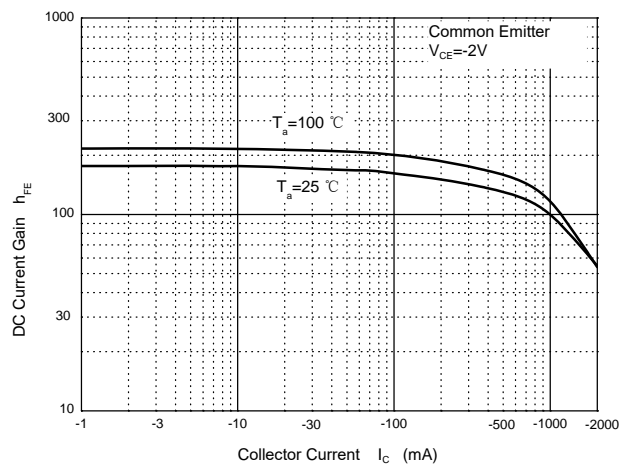
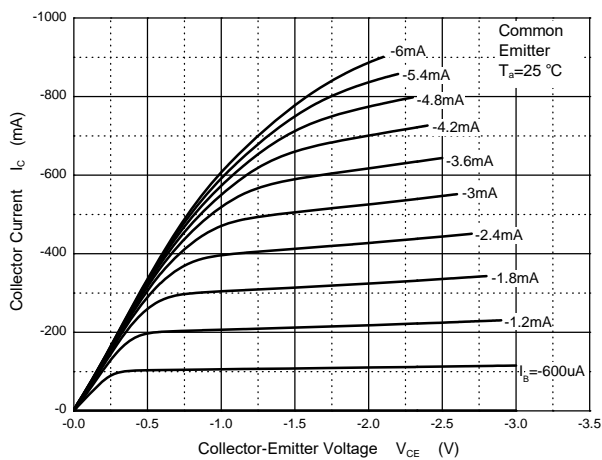

Package Outline

SOT-89

Dimensions in mm

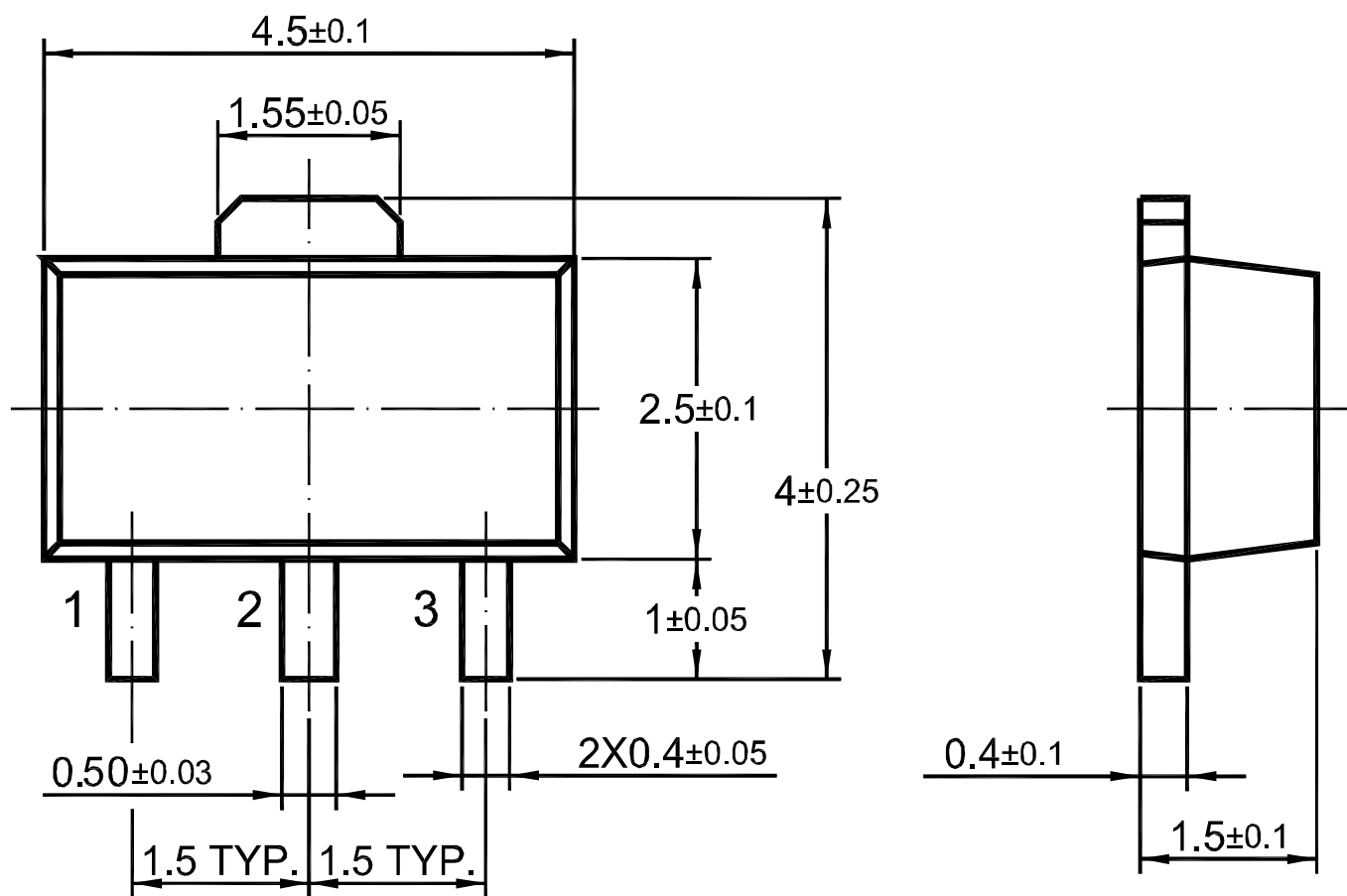

Conditions of Soldering and Storage

◆ Recommended condition of reflow soldering

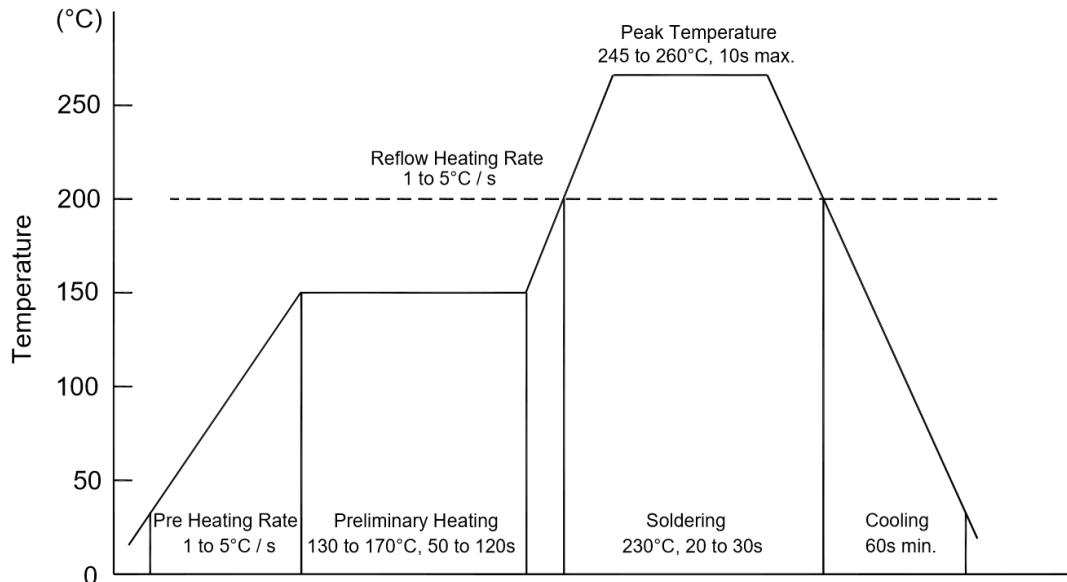

Recommended peak temperature is over 245 °C. If peak temperature is below 245 °C, you may adjust the following parameters:

- Time length of peak temperature (longer)
- Time length of soldering (longer)
- Thickness of solder paste (thicker)

◆ Conditions of hand soldering

- Temperature: 370 °C
- Time: 3s max.
- Times: one time

◆ Storage conditions

- **Temperature**
5 to 40 °C
- **Humidity**
30 to 80% RH
- **Recommended period**
One year after manufacturing